

Varenummer: 2032100M1080A1S
 Beskrivelse: E+G Justerfod
 GN 32-100-M10-80-A1-S
 Note: S Uden møtrik, udvendig sekskant i bunden

Mål

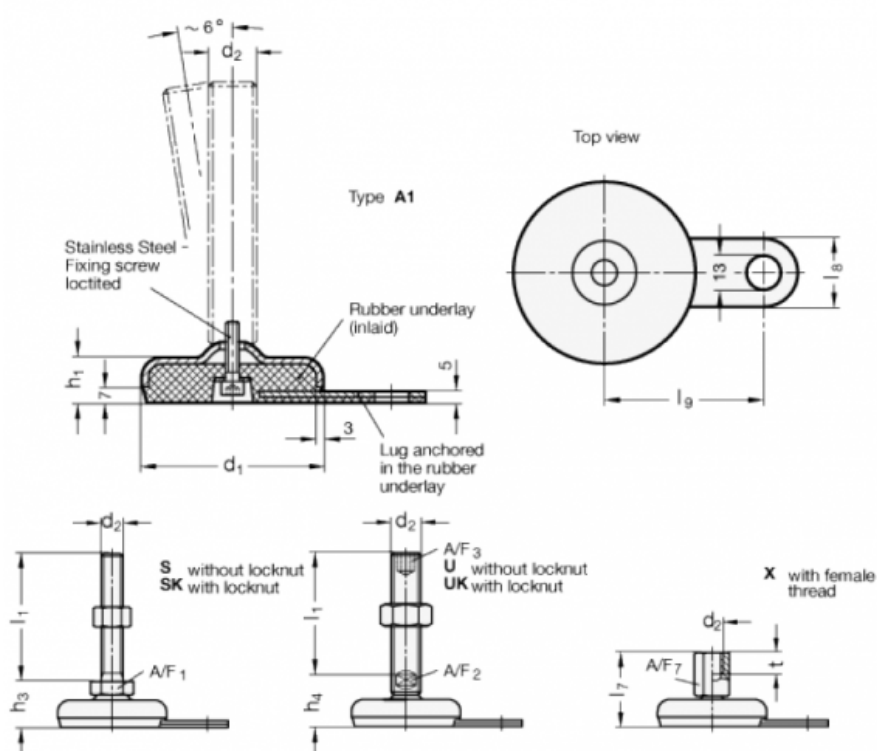

A/F1	=	17
d1	=	100
d2	=	M10
h1	=	21
h3	=	29
l1	=	80
l8	=	30
l9	=	80